

Az atomoktól a csillagokig

Kísérleti bemutató 2011. 12. 08.



Légnyomás

Beeckman (1616): Vízet szivattyúzni csak 10m-ig lehet!

Evangelista Torricelli

1608-1647

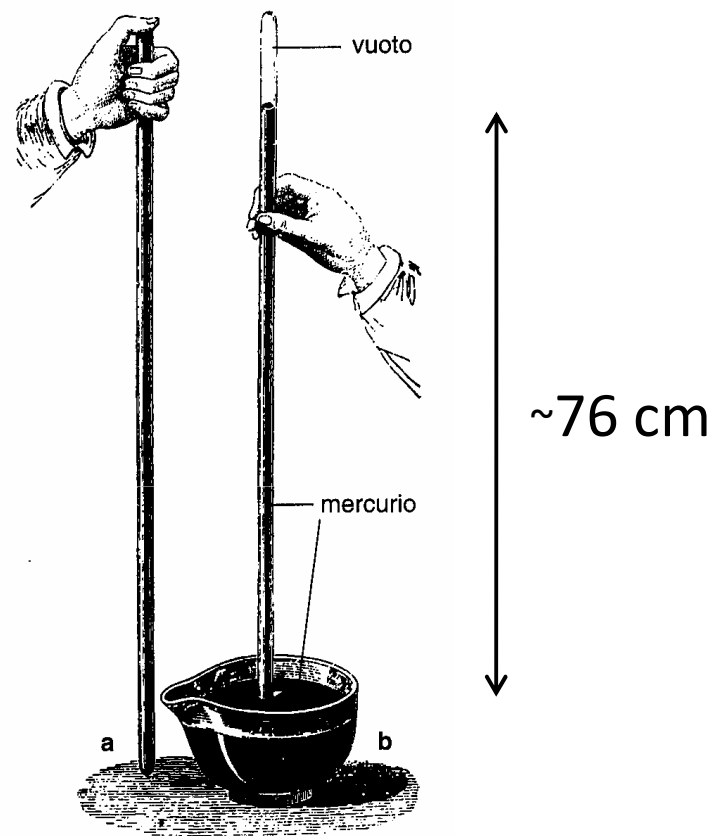

Kísérlet vízzel és borral

Torricelli-kísérlet a Puy-de Dome hegyen (Pascal: 1648) (a légnyomás magasságfüggése): 800 m magasan, 68 cm-es higanyoszlop

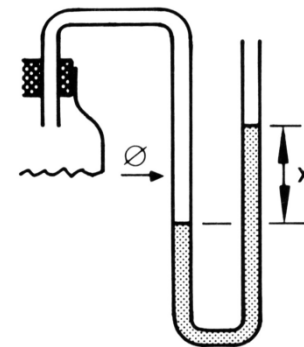
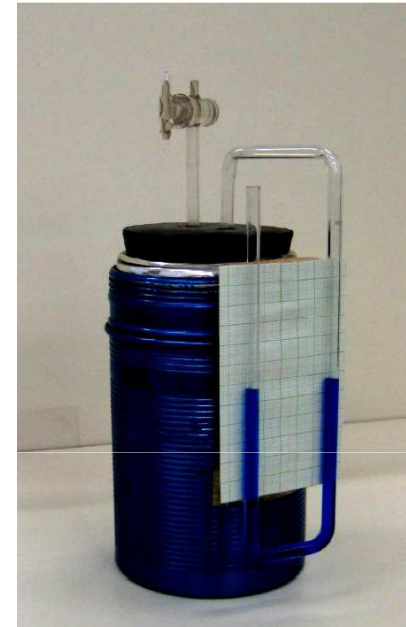
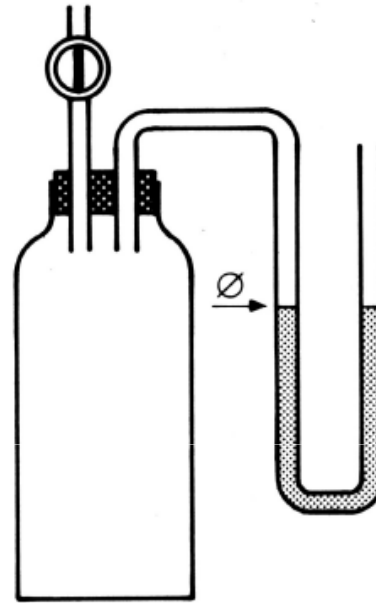
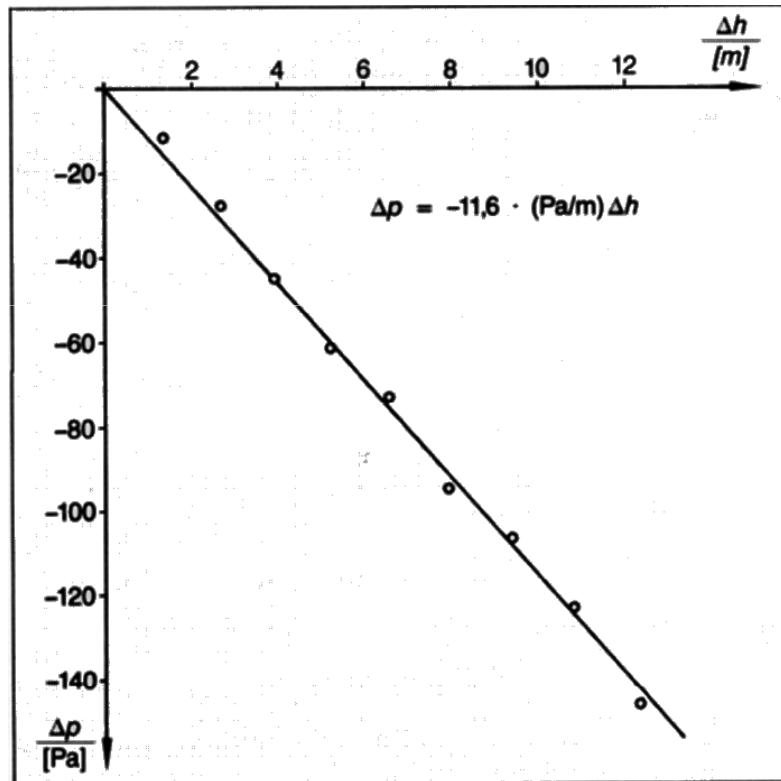

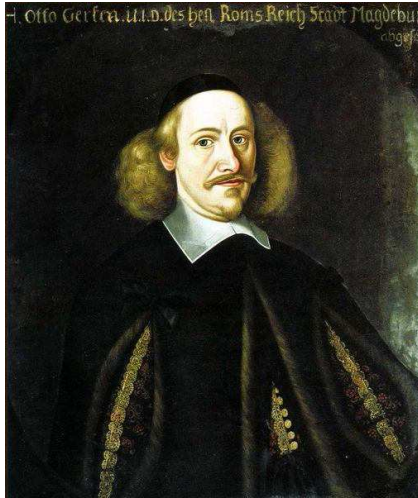

Otto Guericke
1602-1686



Légszivattyú

1654 Regensburgi bemutató



Játékos kísérletek

A légnyomás

Guericke kísérlete az iskolában

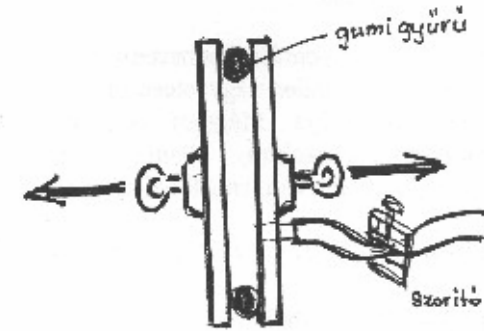
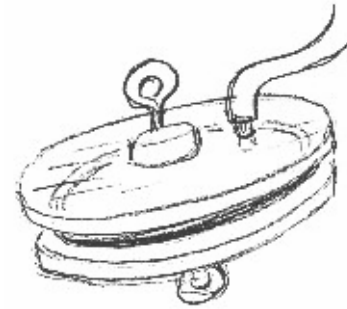

Bűvészmutatvány a légnyomás segítségével

A légkör tömegének érzékeltetése



Mi az erősebb: A levegő vagy a fa?



Gőzhajtású alumínium doboz tömörítő

